

## Machine Applications

- The sturdy design of the SEM 656D makes it the perfect machine for port cargo handling, mineral yards, steel mills and other high demand applications
- In Quarry and Aggregate and Coal Mining applications the 656D can load more, move faster and burn less fuel
- Multiple work tools are available for increased versatility

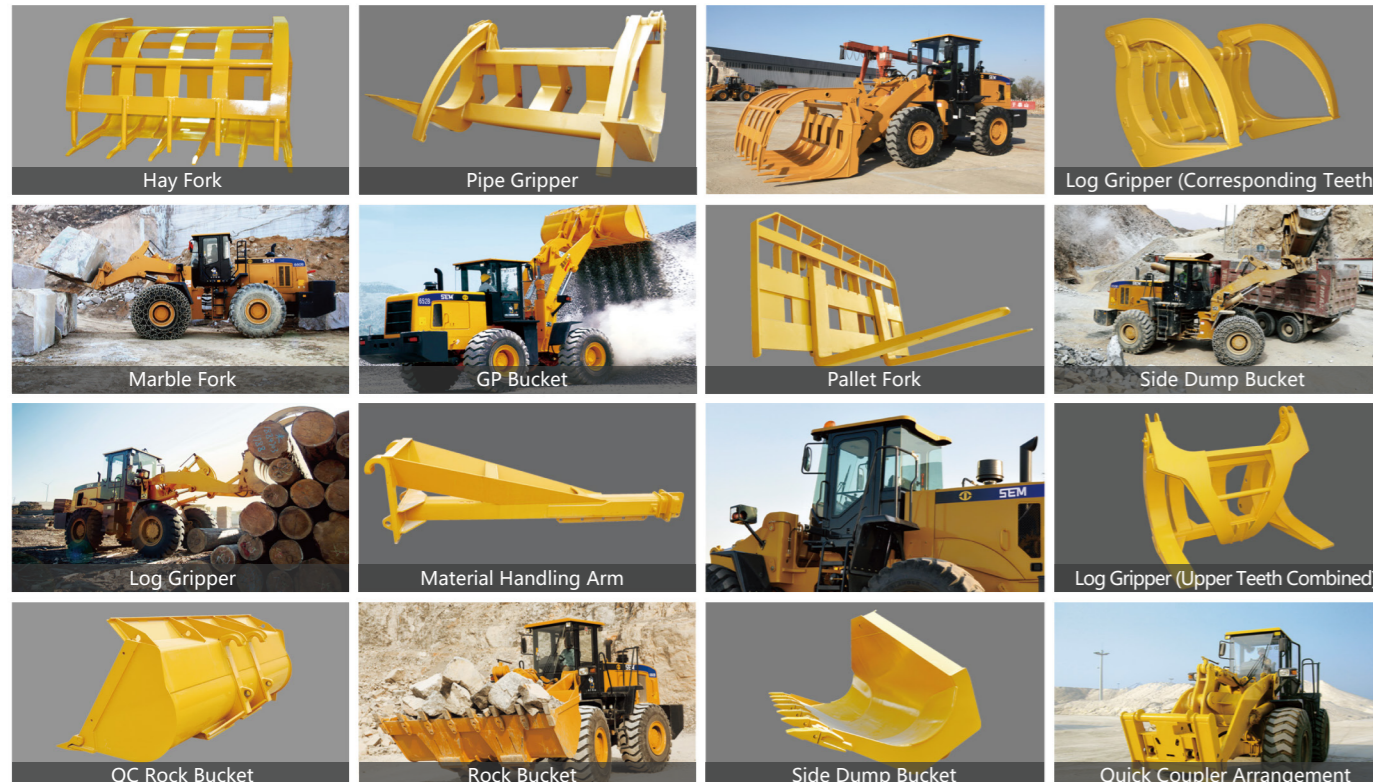

## Work Tool Options



## Main Specifications

Items		SEM656D	Items		SEM656D
<b>Main Specifications</b>			<b>Engine</b>		
Rated Load	kg	5 000	Model		Weichai WD10G
Operating Weight with Standard Bucket	kg	16 900	Rated Power	kW	162
Bucket Capacity	m <sup>3</sup>	2.7-4.5	Rated Speed	r/min	2 000
Wheel Base	mm	3 300	Displacement	L	9.726
Overall Dimension	mm	8 279x2 963x3 457	<b>Implement Hydraulic</b>		
<b>Operating Specifications</b>			Implement System Type		
Breakout Force	kN	178	Implement System Type		Single load sensing flow sharing system
Dump Clearance	mm	3 113	Boom Raise Time	s	5.13
Articulated Angle	°	38±1	Hydraulic Cycle Time	s	9.3
<b>Transmission</b>			System Pressure Setting		
Transmission Type		Countershaft, power shift	System Pressure Setting	Mpa	18
<b>Transmission Gears</b>			<b>Brake System</b>		
Transmission Gears		F4/R4	Service Brake		Dry & caliper, air to oil control
Torque Converter Type		Single stage 3 elements	Parking Brake		Drum type shoe brake, spring applied & oil released
<b>Maker &amp; Type</b>			<b>Steering System</b>		
Maker & Type		TR200	System Type		Flow amplifying
Forward I/ Reverse I	km/h	7.8/7.8	Steering Pump Type		Piston pump
Forward II/ Reverse II	km/h	15/15	System Pressure Setting	Mpa	16
Forward III/ Reverse III	km/h	22/22	Steering Angle (L/R)	°	38±1
Forward IV/ Reverse IV	km/h	39/39	<b>Tires</b>		
<b>Axle</b>			Size		
Axle		SO32	Size		23.5-25
Main Drive Type		Spiral bevel gear, single stage	Type		Bias
Final Drive Reduction Type		Planetary type, single stage	Layer		16
Rear - Oscillating +/-	°	±11	Layer		16
			Textured Type		L3/E3

## Machine Dimensions

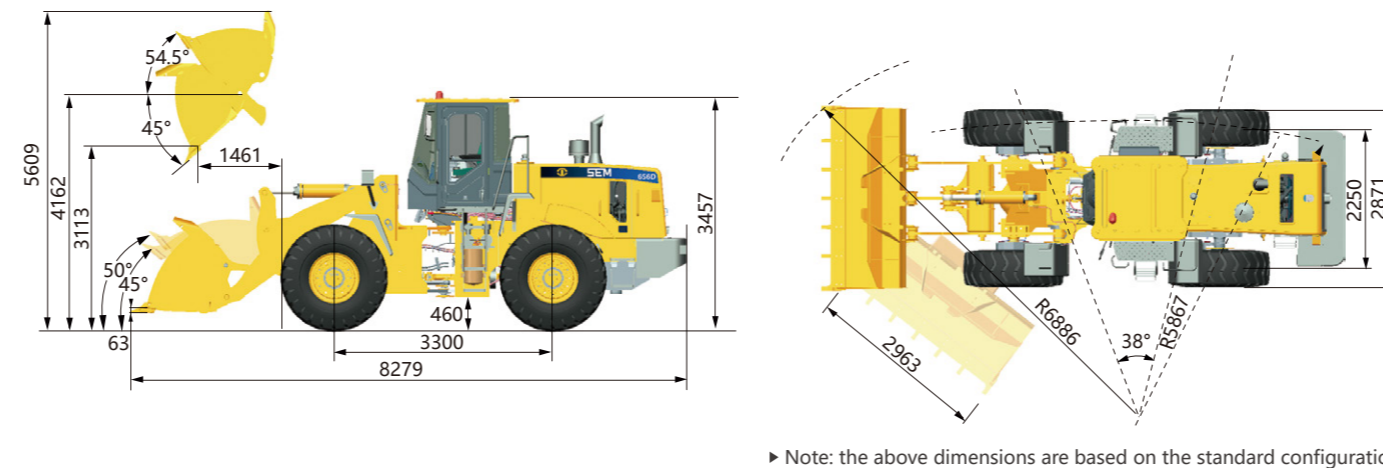

Caterpillar (Qingzhou) Ltd. Address: No.12999 Nanhuan Road, Caterpillar Industrial Park, Qingzhou City, Shandong Province, Zip Code: 262500 P.R.China  
 © Materials and specifications are subject to change without notice. Featured machines in photos may include optional equipment. See your SEM dealer for available options.  
 © 2017 Caterpillar (Qingzhou) Ltd. All Rights Reserved. SEM Machinery, SEM, their respective logos, trade dress as well as corporate and product identity used herein, are trademarks of Caterpillar (Qingzhou) Ltd. and may not be used without permission.  
 Version: February 2017 - Weichai

# SEM656D Wheel Loader



\* Installed with Weichai Engine  
 ※ Featured machines in photos may include optional equipment

## SEM656D

### Product Advantage

- High Productivity
- Excellent Fuel Economy
- Best-in-class Reliability and Durability
- Outstanding Operator Comfort

Website <http://www.semmachinery.com>





## Optimized Engine

- Low speed engine with E-fan provides increased operating efficiency
- Enhanced fuel pre-filter eliminates water and contaminant from fuel for best fuel system protection
- The air cleaner provides machine reliability even in the most severe applications

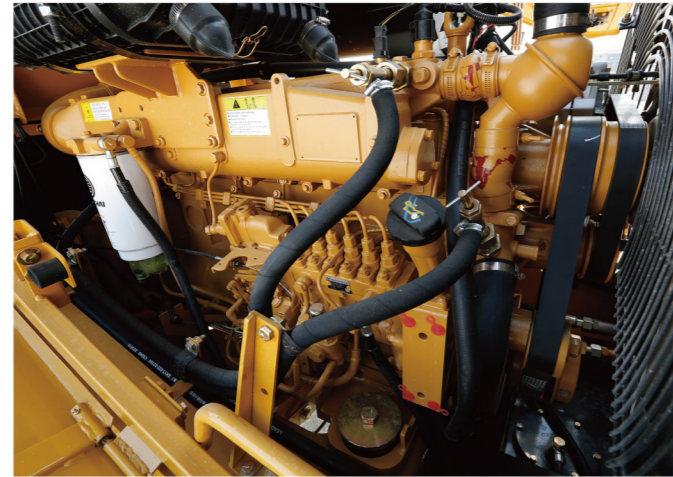

## Efficient Hydraulic System

- The advanced load sensing hydraulic system with flow sharing circuits improves efficiency
- World Class hydraulic components ensure high reliability
- The optimized hydraulic system paired with the drive train reduces machine cycle time and increases productivity

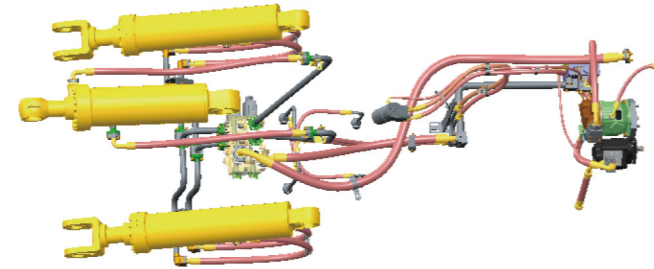

## Operator Station

- Premium operator station with increased space and superior visibility
- Sliding side window and AC with fresh air circulation provide operator comfort
- Joystick hydraulic control for easy and precise operation
- Multi-function instrument dashboard with 3-level alarm
- Adjustable suspension seat



## Reliable Drivetrain

- Countershaft transmission with upgraded core components provides high reliability
- Large rim-pull in 1st gear and higher speed in 2nd gear provide high efficiency for load and carry applications
- Clutch cutoff selection switch ensures stable and safe operation
- The SEM designed and built axle provides best in class performance in heavy duty applications

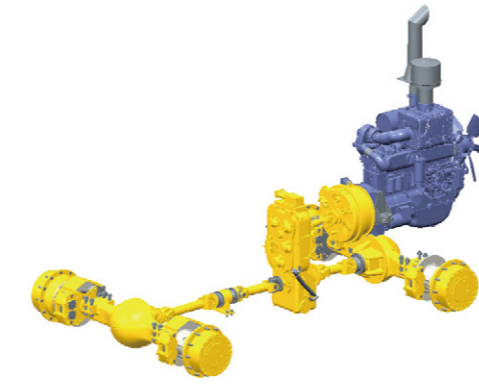

## Advanced Cooling System

- The standard cooling package provides high reliability in 50°C ambient conditions.
- Shock pad mounts ensure reliability under severe applications

## Solid Structure

- Structures undergo Finite Element Analysis (FEA) and On Machine Stress Analysis (OMSA) to ensure durability
- Performance Series (PS) buckets improve loading capability

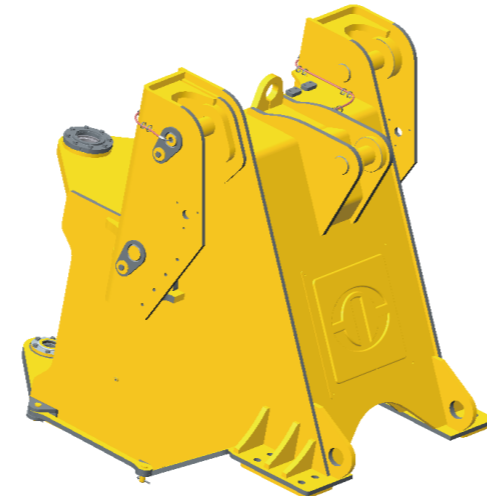

## Serviceability

- Centralized lubrication points reduce maintenance time
- System pressure test ports are standard
- Easy access to external air charge connecting port
- Engine hood grill opens for easy service access
- Torque converter is isolated from transmission making it easy to service

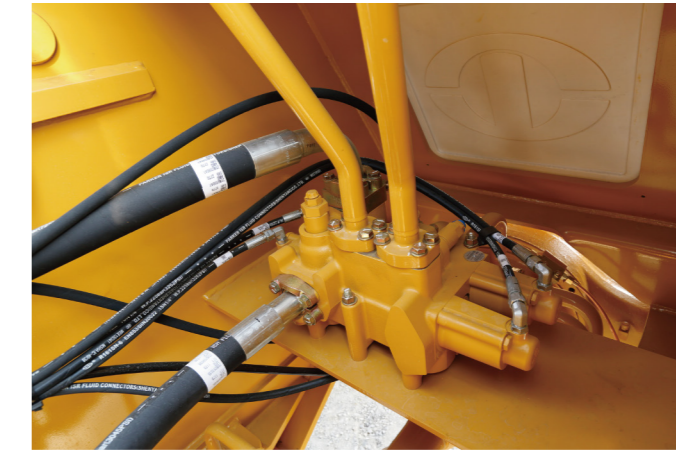

## Safety

- Safety design complies with all regulatory requirements
- Machine is designed with 3 points of contact to ensure operator safety
- A backup alarm, horn and beacon ensure operational safety with ground personnel
- Caterpillar Production System (CPS) leveraged in manufacturing process
- Environmentally friendly painting process

