

Life Is On

Schneider
Electric

Galaxy VM

From 160 kVA to 1000 kVA
Three-phase power protection



apc.com/products

Galaxy VM — trusted partner for your business continuity

Highly efficient, easy-to-deploy, three-phase power protection that seamlessly integrates into the electrical, physical, and monitoring environments of customers' medium data centers, industrial, or facilities applications.

- Very high efficiency with multimode energy management including EConversion™ technology even at very low load levels
- Robust mechanical design with fully isolated input/output cabinet
- Flexible battery solutions
- Seven-inch, color touch-screen display with a separate mimic diagram

Features and benefits

The Galaxy™ VM is a key component of the fully integrated and comprehensive Schneider Electric™ energy management solution for data centers and industrial applications. Deploying the latest in technology, it lowers energy costs through high efficiency and an EConversion mode. State-of-the-art electrical performance options, such as wide input voltage range, high overload and short-circuit capacities, and integrated backfeed protection, allow the Galaxy VM to seamlessly integrate into your electrical network to provide excellent power quality. Highly compact, the Galaxy VM also integrates well with facility monitoring systems requirements, offering energy storage flexibility that tailors the solution to your specific needs. It features top and bottom cable entry, full front service access, back-to-the-wall installation, and includes start-up services, making the Galaxy VM one of the easiest UPS units in its class to deploy, install, and maintain.

Galaxy VM

Integration

- Schneider Electric StruxureWare™ software applications and suites
- Electrical network earthing systems
- Facilities infrastructure
- Seismic certified
- Monitoring systems — BMS, modbus, etc.

Energy and cost savings

- EConversion mode
- High-efficiency double conversion mode
- ECO mode

Energy storage flexibility

- Traditional (VRLA) and modular battery offer
- Common battery available in standard
- Short and long backup times
- Selectable charging modes

Ease of installation

- System designed for ease of cabling in confined installation spaces
- Single cabinet top and bottom cable entry
- Integrated casters for ease of mobility on UPS and modular battery cabinets

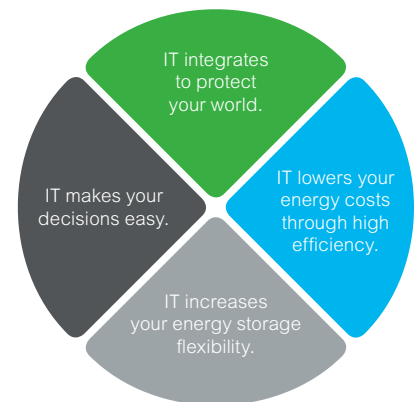

Galaxy VM features

IT integrates to protect your world.

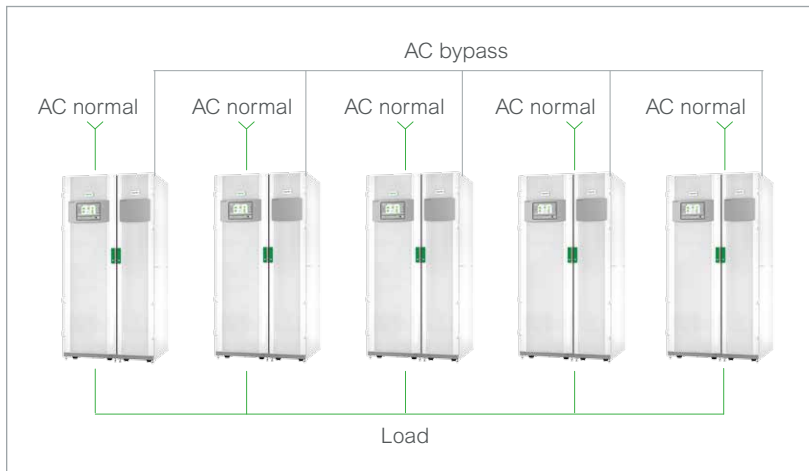
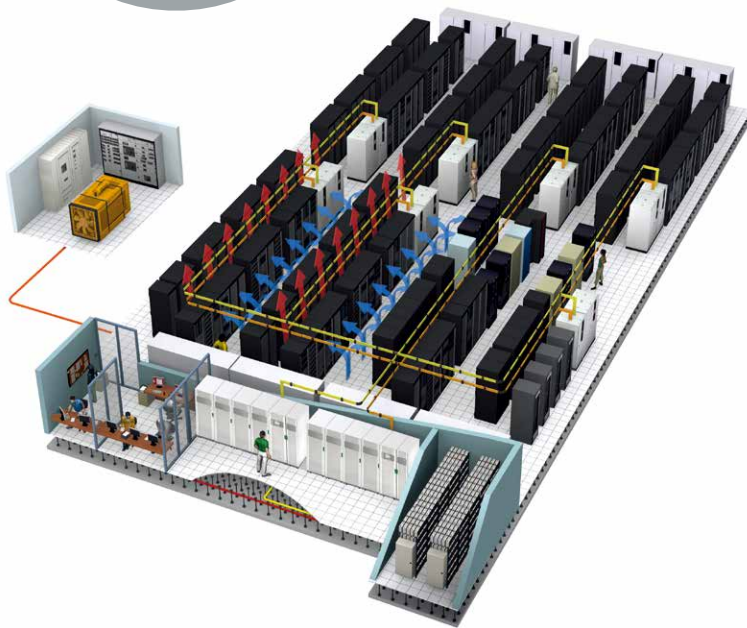
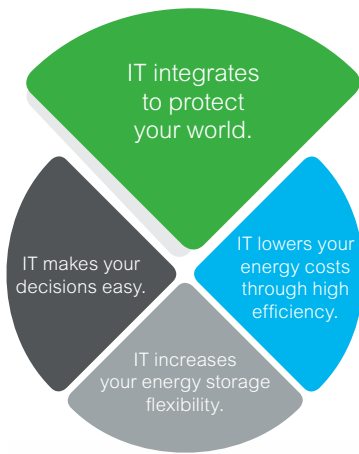

Distributed parallel connection for increased power and redundancy

Integration into your electrical network

- Wide input voltage and frequency ranges
- Genset compliant with adaptive ramp-in
- Integrated parallel capability up to five UPS units
- Built-in integrated and tested backfeed protection

Full integration with Schneider Electric solutions

Fully integrates into the comprehensive Schneider Electric energy management solution for data centers and industrial applications

Smart power test

Ability to test the UPS at full load without the need to rent a load bank and before bringing customers' load online

Integration into your facility infrastructure

- Compact footprint
- Back-to-the-wall installation
- Operates at 40 °C continuously without de-rating
- Embedded seismic certified to OSHPD, IBC2012 and CBC2013 to Sds=2.02 g
- Low audible noise levels
- Replaceable dust filter for harsh environments
- Configurable input/output relays
- Top and bottom cable entry
- Parallel capability to increase multiple UPS systems for capacity or redundancy
- Ability to add UPSs in a parallel configuration without the need to transfer the load to bypass
- Cold start: capability to start the UPS on battery without mains power present
- External synchronization capability

Galaxy VM features

IT lowers your energy costs through high efficiency.

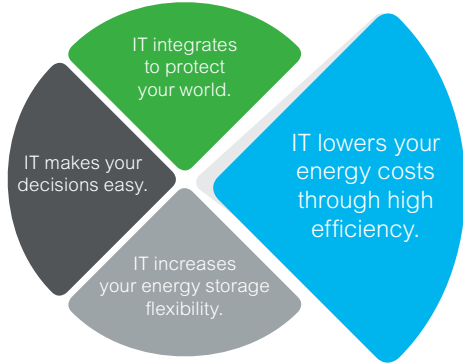

High-efficiency operating modes

ECONversion mode

- Ultrahigh efficiency up to 99%
- Keeps excellent load protection
- Continuously charged batteries
- Compliant with IEC 62040-3 Class 1 output voltage of UPS standard
- Input power factor correction and no harmonics

Double conversion mode

- Up to 96.5% efficiency in double conversion online mode even at low load levels
- Less energy losses = cost savings
- Less heat dissipation = lower cooling needed, hence cost savings

ECO mode

- Up to 99.5% efficiency
- Compliant with IEC 62040-3 Class 3 output definition of UPS standard

ECONversion mode

Enables control of input current to almost same quality as known from on-line UPS

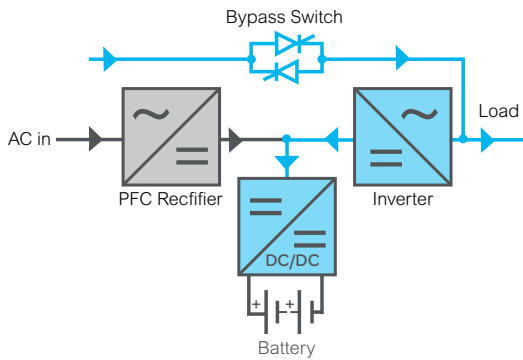

Galaxy VM ECONversion meets Class 1 of IEC 62040-3: zero break transfer during power outage

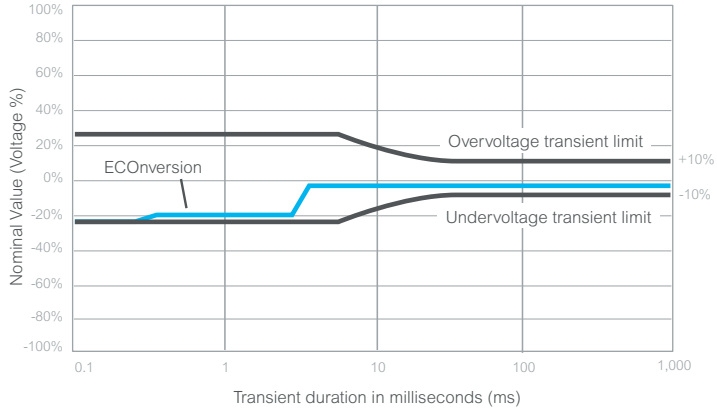

Cost savings by using Galaxy VM

Very high efficiency for small to medium data centers, buildings, and facilities

At 100% load	Alternate UPS	Alternate UPS	Alternate UPS
Efficiency	95%	94%	93%
Savings by using Galaxy VM/year (in ECONversion mode)	€23,700	€29,625	€35,550
Ten-year savings by using Galaxy VM (in ECONversion mode)	€237,000	€296,250	€355,500

Considering a total UPS load of 720 kW (4 x 200 kVA running at 100 percent load).

At the national average rate of €0.07/kWh, a 720 kW Galaxy VM installation running in ECONversion mode (99% efficiency) can save €296,250 for 10 years compared to a 720 kW UPS with 94 percent efficiency.*

In the same scenario, a Galaxy VM operating in double conversion mode (> 96.5% efficiency) has cost savings equal to €130,350 over five years compared to a 720 kW UPS with 94 percent efficiency.

*Figures calculated using APC™ by Schneider Electric UPS efficiency comparison calculator are estimates. Individual savings could vary.

Galaxy VM features

IT increases your energy storage flexibility.

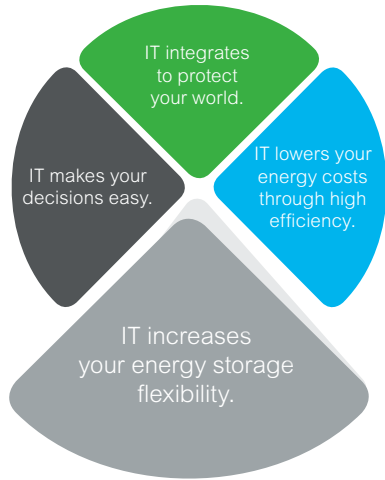

Advanced individual battery string monitoring for both current and voltage



Modular battery cabinets

Energy storage options

- Traditional (VRLA) battery offer:
 - Choice of multiple runtime options and battery cabinet configurations
 - Each cabinet has only one battery string with its own DC breaker and slide-out shelves that are designed for ease of use
- Modular battery offer:
 - Ease of scaling in smaller increments provides customizable backup time or redundancy
 - Advanced string monitoring of current and voltage impedance allows for predictive information of the batteries
 - Battery replacement without the need to go to bypass keeps the load protected
- Matching wall-mounted battery breaker box and battery breaker kits as well as empty battery cabinets are available
- Parallel UPS configurations can be connected to a common battery without the need for a battery coupling cabinet, reducing footprint and increasing cost savings
- Flywheel and lithium ion compatibility



Classical battery cabinet: seismic IBC level 2 with battery disconnect at string level



Wall-mounted battery breaker box

Galaxy VM features

IT makes your decisions easy.

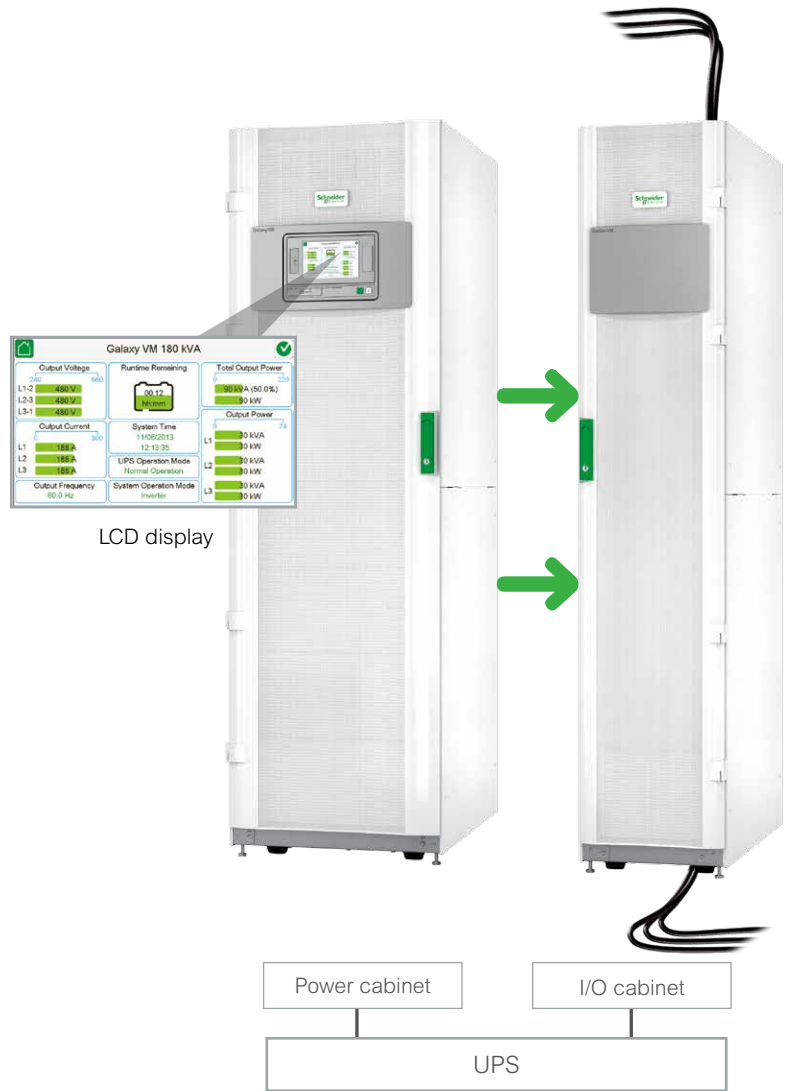

From ordering to installation, the Galaxy VM makes your solution choice easy.

Start-up

- 5 x 8 start-up services are included, allowing for full coverage of factory warranty
- Remote monitoring service included for first year

Installation

- Casters allow UPS configurations to be moved easily and installed up against the wall
- Separate I/O cabinet for input and output cabling ensures quick, error-free, and easy installation
- Top and bottom cable entry standard provides great flexibility to the installer

Monitoring

- 7-inch, color touch-screen display
- Integrated network management capability for easy access to the network
- Integrated battery monitoring capability included for modular battery offer
- Modbus (SCADA and ION-E) capability
- Customizable dry contacts and relays

Galaxy VM management card compatibility chart

SKU/part number	Description	Protocol supported
Included with Galaxy VM	<ul style="list-style-type: none"> • 1 plug: Ethernet SNMP (similar to AP9630) • 1 plug: RS485 modbus RTU • 6 configurable dry contacts IN • 10 configurable dry contacts OUT • 2 free slots for optional communication cards 	<ul style="list-style-type: none"> • HTTP, HTTPS, IPv4, IPv6, NTP, SMTP, SNMP v1, SNMP v3, SSH V1, SSH V2, SSL, TCP/IP, Telnet, and modbus RTU • Optional com cards : AP9635CH, AP9631, AP9630
AP9635CH	UPS network management card 2 w/ environmental monitoring up to 1 sensor, out-of-band access, and modbus capabilities	HTTP, HTTPS, IPv4, IPv6, NTP, SMTP, SNMP v1, SNMP v3, SSH V1, SSH V2, SSL, TCP/IP, Telnet, modbus RTU, modbus TCP/IP
AP9631	Remote monitoring and control of an individual UPS by connecting it directly to the network — card also has environmental monitoring for up to 2 sensors	HTTP, HTTPS, IPv4, IPv6, NTP, SMTP, SNMP v1, SNMP v2c, SNMP v3, SSH V1, SSH V2, SSL, TCP/IP, Telnet
AP9630	Remote monitoring and control of an individual UPS by connecting it directly to the network	HTTP, HTTPS, IPv4, IPv6, NTP, SMTP, SNMP v1, SNMP v3, SSH V1, SSH V2, SSL, TCP/IP, Telnet

StruxureWare for Data Centers software suite

In the data center environment, Galaxy VM is fully managed through StruxureWare for Data Centers software, an integrated suite of data center infrastructure management applications. It enables businesses to prosper by managing their data centers across multiple domains, providing actionable intelligence for an ideal balance of high availability and peak efficiency throughout the entire data center life cycle. StruxureWare software applications and suites are key elements of Schneider Electric EcoStruxure™ integrated hardware and software system architecture — a system designed for intelligent energy management.



A comprehensive portfolio of services

Schneider Electric Critical Power & Cooling Services provides the expertise, services, and support you need for your building, industry, power, or data center infrastructure. Our world-class life cycle services offer a smart way to install and maintain your critical applications, ensuring your systems are always running at peak performance.

Assembly and start-up service by a certified Field Service Engineer (FSE) allows full factory warranty coverage. A Schneider Electric-certified installation makes certain your equipment is properly configured for optimal performance. This service features a standard eight-hour, five-day response time, with upgrades available for off-business hours.

On-site warranty extension service

In the case of a system event, an FSE will arrive by the next business day (or faster with upgrades) to isolate, diagnose, and correct in as little time as possible, minimizing downtime.

Advantage plans

Flexible service packages offer smooth system maintenance to improve uptime at a predictable cost. The Advantage Plus, Prime, Ultra, and Max are full-service packages that include technical support, preventive maintenance, quick on-site response, and remote monitoring. Response time upgrades are available.

Remote monitoring service (RMS)

RMS is an economical and easy-to-use Web-based service that lets you quickly respond to environmental or system changes. Trained technicians provide secure 24-hour monitoring of your physical infrastructure to diagnose and resolve events before they become critical.

Preventive maintenance

Preventive maintenance on-site examinations keep your critical systems running at maximum efficiency.

Rated power (kVA/kW)	160/144	200/180	320/288	400/360	480/432	600/540	640/576	800/720	1000/900
Normal AC supply input									
Input voltage (V)	250 – 600 V								
Normal and bypass AC inputs	Single input or dual input as standard								
Frequency (Hz)	40 – 70 Hz								
Input power factor	0.99								
THDI	< 3% full load								
Bypass AC input									
Input voltage range	342 – 457 V								
Frequency	50 Hz or 60 Hz								
Output									
Phase-to-phase output voltage (V)	380/400/415 V								
Load power factor	0.9 (0.7 leading to 0.5 lagging without de-rating)								
Output frequency	50/60 Hz +/- 0.1% (free-running)								
Overload capacity utility operation at 40 °C	150% for 1 minute and 125% for 10 minutes								
Output voltage regulation	+/- 1%								
Total harmonic distortion (THDU)	< 2% at 100% linear load; < 3% at 100% nonlinear load								
Output voltage tolerance	Symmetric load (0 – 100%): +/- 1% static; asymmetric load: +/- 3% static								
Overall efficiency									
ECONversion mode (meets EN62040-3 Class 1)	Up to 99% (meets EN62040-3 Class 1)								
Efficiency at full load (AC-AC) at 100% load	Up to 96.5%								
Standard ECO mode	Up to 99%								
Communication and management									
Control panel	Multifunction 7" touch-screen color LCD display with built-in NMC, modbus (SCADA and ION-E), two empty NMC card slots								
Dimensions and weights									
UPS (H x W x D) mm	1970 x 1052 x 854	1970 x 2104 x 854	1970 x 3156 x 854	1970 x 4208 x 854	1970 x 5260 x 854				
Weight in kg. (UPS) (total -power cabinet plus I/O cabinet)	699	724	1398	1448	2097	2172	2796	2896	3620
Regulatory									
Safety	IEC 62040-1								
EMC/EMI/RFI	IEC 62040-2								
Markings	CE, C-Tick								
Performance	IEC 62040-3, VFI -SS -111								
Transportation	ISTA 2B								
Seismic zone	IBC Level 2:2006								
Environmental									
Operating temperature	0 °C – 40 °C								
Storage temperature	-25 °C to 55 °C — without batteries -15 °C to 40 °C — with batteries								
Relative humidity	0% – 95% non-condensing								
Operating elevation	1,000 m. at 100% load								
Storage elevation	0 – 15,000 m								
Max. audible noise at 1 m from unit	55 dB at 70% load, 65 dB at 100% load								

Schneider Electric

132 Fairgrounds Road
West Kingston, RI 02892
USA
email: esupport@apc.com

www.schneider-electric.com

June 2016

©2016 Schneider Electric. All Rights Reserved. Schneider Electric | Life Is On, ECONversion, Galaxy, StruxureWare, APC, and EcoStruxure are trademarks and the property of Schneider Electric SE, its subsidiaries, and affiliated companies. All other trademarks are the property of their respective owners. • 998-1203811_50hz_IEC_B

Life Is On

Schneider
Electric